

**FD010150**  
**MEDIAS CAÑAS**  
**D-SHAPE**

- 1x0.3
- 2x0.75
- 3x1
- 4x1.25
- 5x1.5
- 6x2
- 7x2.25
- 8x2.5

# LAMINADORES MANUALES SOBREMESA

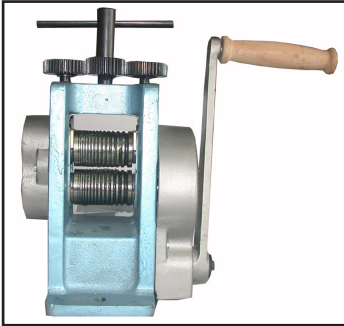

Manual  
 Apertura - Opening 6 mm.  
 Kgs. 18  
 Dimens. Mm. 260x220x400

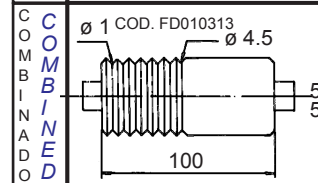
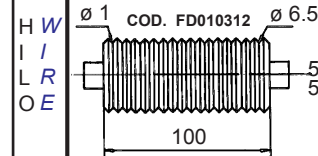
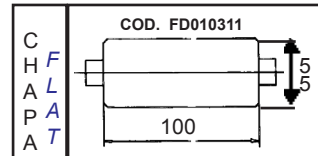
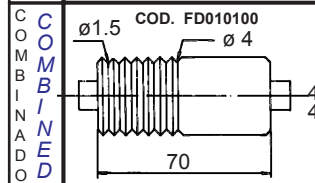
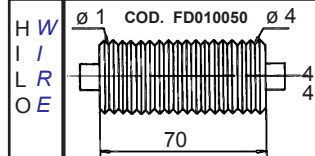
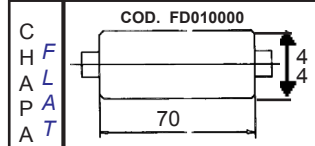

**L-100**  
**100\*55 mm**  
 Manual  
 Apertura - Opening 5,5 mm.  
 Con ruletas - With roulettes  
 Kgs. 28  
 Dimens. Mm. 295x216x400

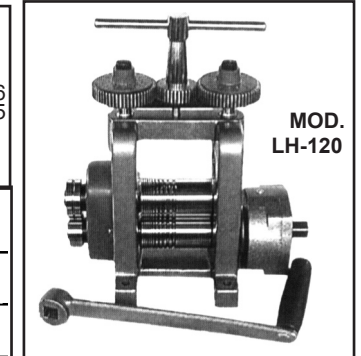
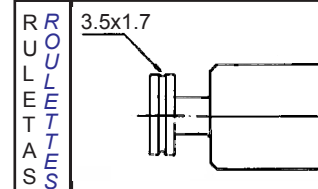
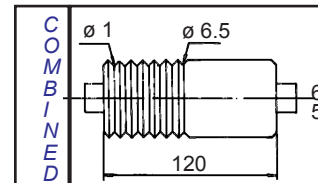

MOD. LH-120  
 Manual  
 Apertura - Opening 5,5 mm.  
 Con reductor - With reducer  
 Kgs. 35  
 Dimens. Mm. 340x215x415

COD. FD010371

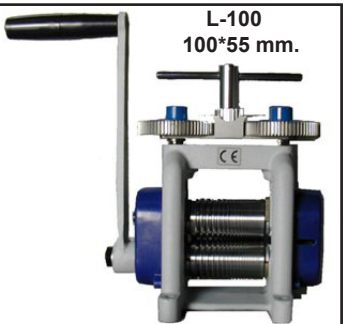
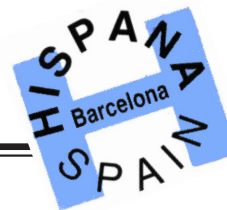

**L-100**  
**100\*55 mm.**  
 Manual  
 Apertura - Opening 6 mm.  
 Kgs. 18  
 Dimens. Mm. 260x220x400

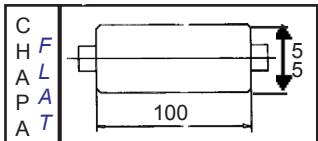
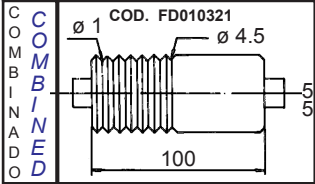
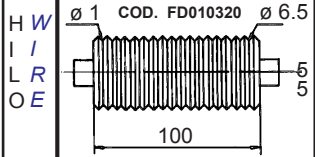
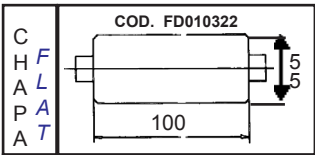

Manual  
 Apertura - Opening 5,5 mm.  
 Kgs. 38  
 Dimens. Mm. 300x240x430

COD. FD010310



## HAND DRIVEN OVERBENCH ROLLING MILLS

# HISPANA

de Maquinaria, S.A.

Tel. +34 93 3091707 Fax. + 34 93 3090702

e-mail: hispana@hispanaspain.com

internet: http://www.hispanaspain.com

C/ Can Cuiàs, 24-26 - Pol.Ind. Can Cuiàs, nave 20/1  
 Montcada i Reixac 08110 - Barcelona - España (Spain)